

Technical datasheet

SIBER® HRV EVO 2 PR



Compact High-Performance HRV Unit with Preheater

The Siber HRV EVO 2 PR unit is a high performance heat recovery unit with constant flow ventilation technology, centrifugal fans with direct current and forward inclined blades, thus ensuring constant flow, acoustic comfort, reduced electrical consumption, easy maintenance and optimum air quality.

TECHNICAL ADVANTAGES

- Built-in 1kW preheater
- Constant airflow technology
- Wide variety of filters
- Better energetic efficiency (up to 95%)
- Silent running
- 100% automatic by-pass
- Control through wireless connection (RF)
- Passivhaus Institute Certification 

SIBER HRV EVO 2 PR



INSTALLATION ADVANTAGES

- Quick & easy installation
- Orientable connections with integrated EPDM bands for a better sealing
- Double rotating condensation drain
- Orientative rails for both laterals
- Vertical or Horizontal installation
- Perfectly parallel instalation
- No inclination needed for the condensation drain

PREHEATER

The built-in preheater serves as a frosting protection, increasing the resistance of the unit up to -35°C

The casing is made of AluZinc coated steel, which is highly resistant to corrosion

The resistors are made of AISI304L stainless steel. Power 1 kW

Equipped with automatic protection clixon regulated at 40°C that prevents overheating

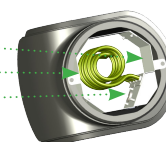

CERTIFICATIONS



APP



MAX. AIRFLOW: 200 m³/h

Slim unit- 8.2 inch

Thanks to its aerodynamic design, it reaches a better airflow with less pressure, being more efficient energetically.

DIMENSIONS / AIRFLOW

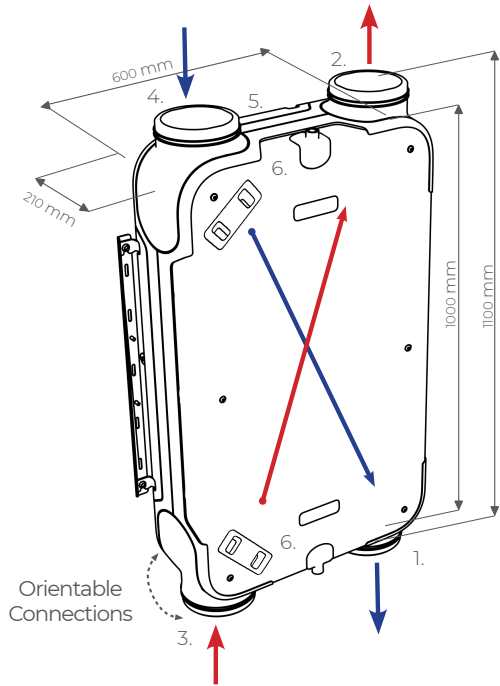

CAPTION

1. Insufflation of new air into the house
2. Extraction of foul air to the outside
3. Extraction of foul air from the inside of the home
4. New air's intake from outside
5. Electrical connections
6. Condensation drain connection



* It can only have one condensation drain, the other one has to remain closed with a plug.

Airflow in right mode
(factory version)

A height of only 21 cm / 8.2 inch
Optimize the space in false ceiling



PERFECTLY PARALLEL TO THE CEILING

Its design allows to install it perfectly horizontally without the 2° degree inclination for the condensation drain

OPTIONAL ACCESSORIES

- Filter G4 COARSE 65%
- Filter F7 EPM1 55%
- Filter G4_F7 (combined) COARSE 65% - EPM1 55%
- Filter de Carbono
- Filter F9 EPM 1 80%
- Filter G4_F9 (combined) COARSE 65% - EPM1 80%
- Dry siphons (flexible/ball)
- Wireless smart multicontrol (RF)
- Wireless 4-Position Push Button Control (RF)
- Smart wireless CO₂ sensor (RF)
- Smart wireless humidity sensor (RF)
- Gateways/Home Automation convert your house into a Smart Home (Modbus / KNX)
- Bridge for Siber EVO App for smart monitoring

*Refer to our catalogue to see the full range of available accessories

CONVERT YOUR HOUSE INTO A SMART HOME (optional)



Connectivity through:

KNX

Modbus
(Siber APP EVO connection from the ethernet gateway)



Thanks to the smart control, you get a full online monitoring of the most essential functionalities.

TECHNICAL DATA

Voltage supply	230V / 50 Hz				
Protection degree	IP 44				
Dimensions (L x W x H)	1000 x 600 x 210 mm				
Connections diameter	Ø 160 mm				
Condensation drains diameter	1/2"				
Weight	24 kg				
Filter classification (included): Extraction/Insufflation	FILTER G4 COARSE 65% / FILTER F7 EPM1 55%				
Fans positions (factory presets)					
Wireless smart multicontrol (optional)	0	1	2	3	Maximun
Airflows (m³/h)	30	75	100	150	200

ACCOUSTIC LEVEL

Airflow (m³/h)		75	125	150	200		
Acoustic power Lw (A)	Static pressure (Pa)	25	50	50	100	150	200
	Box irradiation (dB(A))	33	42	44	46	51	56
	Extraction duct (dB(A))	34	43	45	48	50	57
	Insufflation duct (dB(A))	46	51	59	62	65	66
Acoustic pressure Lp (A) at 1.5m	Box radiation (dB(A))	18	27	29	31	36	41

AIRFLOW/PRESSURE CURVE

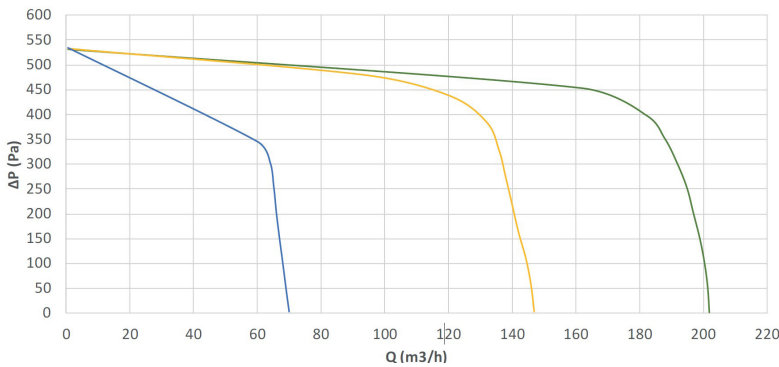

- low speed
- half speed
- maximum speed

WORKING POINTS	FLOW (m³/h)	PRESSURE (Pa)	POWER (W)	SFP (W/l/s)
1	75	25	12.61	0.61
2	100	75	25.31	0.91
3	125	50	29.16	0.84
4	150	50	39.20	0.94
5	150	100	49.65	1.19
6	150	150	60.92	1.46
7	150	200	72.60	1.74
8	200	100	81.33	1.46
9	200	150	93.10	1.68
10	200	200	106.48	1.92

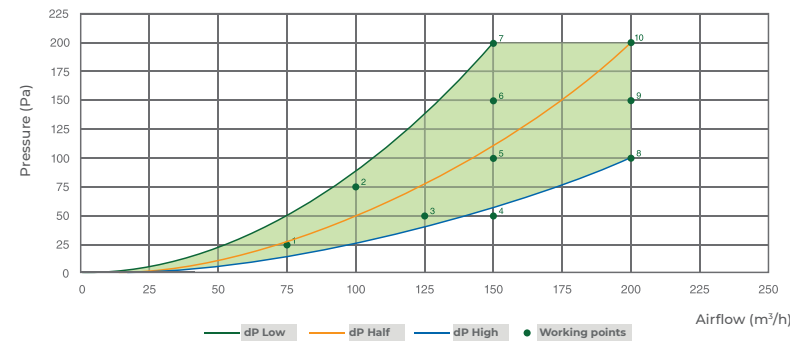

SUSTAINABILITY



SUSTAINABILITY



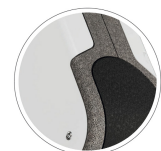





Construction in expanded polypropylene and galvanized steel, reducing the consumption of resources and the degradation of the planet.

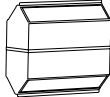
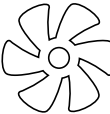

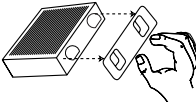
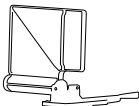
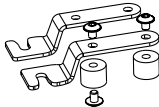
HIGH PERFORMANCE TECHNICAL CHARACTERISTICS

Description

Picture

High performance heat exchanger	Standard, cross flow heat exchanger	
Constant flow fans	Constant flow ventilation technology, direct current centrifugal fan and forward inclined blades. Thanks to this technology, constant flow, acoustic comfort, reduced electrical consumption, easy maintenance and optimum air quality are ensured.	
High efficiency filters (optional)	It has the widest range of filtering on the market, to guarantee optimum air quality. DFFG4 - FILTER G4 COARSE 65% (1 filter included) DFFF7 - FILTER F7 EPM1 55% (1 filter included) DFFG4F7 - COMBINED FILTER G4 + F7 COARSE 65% - EPM1 55% DFFCA - CARBON FILTER DFFF9 - FILTER F9 EPM1 80% DFFG4F9 - COMBINED FILTER G4 + F9 COARSE 65% - EPM1 80% DFFCAG4 - CARBON FILTER + G4	
Easy maintenance	Easy access to filter cleaning, directly through the front panel. Simple access and removal of the heat exchanger and fans (recommended every 3 years)	
Smart bypass	The 100% automatic by-pass serves both in summer and winter to enjoy any favorable temperature situation inside the house without going through the heat exchanger. This management is automatic (factory configured).	
Quick and easy assembly	Mounting possible both on the ceiling and on the wall, with the possibility of installing the guides on all sides of the equipment thanks to the versatility of the silentblock hooks.	
High performance construction	Watertight internal construction in expanded polypropylene (PPE), and external in galvanized steel covered with RAL 9003 thermo-lacquered paint, guaranteeing acoustic and thermal insulation and air tightness	
Adjustable connections	Modularity in the connection quickly and easily. The connections are designed to ensure maximum tightness. Double symmetric EPDM gasket that guarantees the tightness of the distribution system with the unit	
Low consumption	High performance motors with exclusive technology, ensuring the lowest energy consumption	
Wireless regulation (optional accessories)	With connection to wireless controls and sensors (CO ₂ and Relative Humidity). · Wireless intelligent multicontrol remote with electronic regulation and filterfouling indicator. · 4-positions wireless push-button control with LED filter fouling indicator.	
Siber App EVO (optional accessory)	Intelligent control system for online monitoring of the most important elements of indoor air quality in the house	
Gateway/home automation (optional accessories)	KNX - Modbus connectivity. Turn your house into a smart home.	