

# Technical datasheet

## SIBER® ERV EVO 2



### Compact High-Performance ERV Unit

The Siber ERV EVO 2 unit is a high performance heat recovery unit with constant flow ventilation technology, centrifugal fans with direct current and forward inclined blades, thus ensuring constant flow, acoustic comfort, reduced electrical consumption, easy maintenance and optimum air quality.

### TECHNICAL ADVANTAGES

- Partial humidity recovery
- Constant airflow technology
- Wide variety of filters
- Better energetic efficiency (up to 90%)
- Silent running
- 100% automatic by-pass
- Control through wireless connection (RF)
- Passivhaus Institute Certification 

### SIBER ERV EVO 2



### INSTALLATION ADVANTAGES

- Quick & easy installation
- Orientable connections with integrated EPDM bands for a better sealing
- Double rotating condensation drain
- Orientative rails for both laterals
- Vertical or Horizontal installation
- Perfectly parallel installation
- No inclination needed for the condensation drain
- One unit, two modes (left/right)

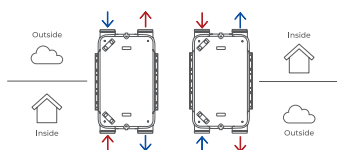

#### CERTIFICATIONS



#### APP



MAX. AIRFLOW: 200 m<sup>3</sup>/h

Slim unit- 8.2 inch

Thanks to its aerodynamic design, it reaches a better airflow with less pressure, being more efficient energetically.

## DIMENSIONS / AIRFLOW

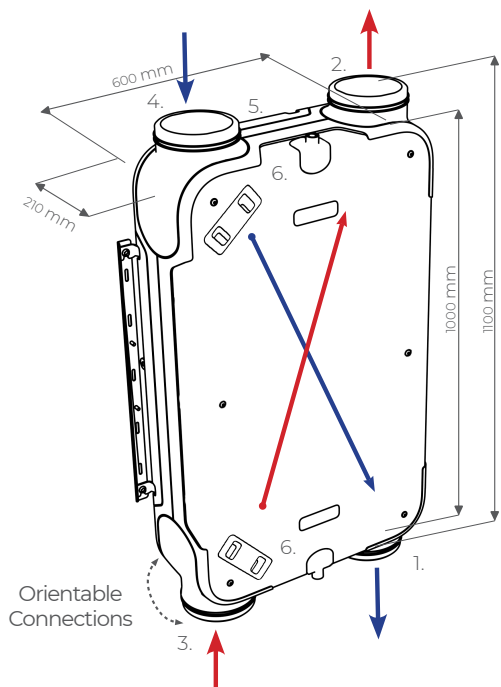

Airflow in right mode  
(factory version)

### CAPTION

1. Insufflation of new air into the house
2. Extraction of foul air to the outside
3. Extraction of foul air from the inside of the home
4. New air's intake from outside
5. Electrical connections
6. Condensation drain connection

\*The enthalpy version has the 2 drains closed with two plugs, they must not be connected to the condensate drain

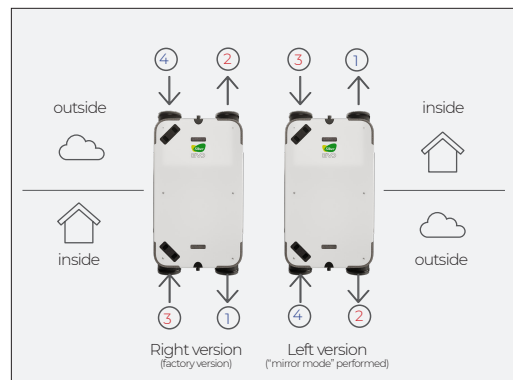

- ① Insufflation inside
- ② Expulsion outside
- ③ Extraction of foul air
- ④ New air intake

A height of only 21 cm / 8.2 inch  
Optimize the space in false ceiling



### PERFECTLY PARALLEL TO THE CEILING

Its design allows to install it perfectly horizontally without the 2° degree inclination for the condensation drain

## OPTIONAL ACCESSORIES

- Filter G4 COARSE 65%
- Filter F7 EPM1 55%
- Filter G4\_F7 (combined) COARSE 65% - EPM1 55%
- Filter de Carbono
- Filter F9 EPM1 80%
- Filter G4\_F9 (combined) COARSE 65% - EPM1 80%
- Wireless smart multicontrol (RF)
- Wireless 4-Position Push Button Control (RF)
- Smart wireless CO<sub>2</sub> sensor (RF)
- Smart wireless humidity sensor (RF)
- Gateways/Home Automation convert your house into a Smart Home (Modbus / KNX)
- Bridge for Siber EVO App for smart monitoring

\*Refer to our catalogue to see the full range of available accessories

## CONVERT YOUR HOUSE INTO A SMART HOME (optional)



Connectivity through:  
**KNX**  
**Modbus**  
(Siber APP EVO connection from the ethernet gateway)

Thanks to the smart control, you get a full online monitoring of the most essential functionalities.



## TECHNICAL DATA

Voltage supply	230V / 50 Hz				
Protection degree	IP 44				
Dimensions (L x W x H)	1000 x 600 x 210 mm				
Connections diameter	Ø 160 mm				
Condensation drains diameter	1/2"				
Weight	24 kg				
Filter classification (included): Extraction/Insufflation	FILTER G4 COARSE 65% / FILTER F7 EPM1 55%				
Fans positions (factory presets)					
Wireless smart multicontrol (optional)	0	1	2	3	Maximun
Airflows (m³/h)	30	75	100	150	200

## ACCOUSTIC LEVEL

Airflow (m³/h)		75	125	150	150	200	200
Accoustic power Lw (A)	Static pressure (Pa)	25	50	50	100	150	200
	Box irradiation (dB(A))	33	42	44	46	51	56
	Extraction duct (dB(A))	34	43	45	48	50	57
	Insufflation duct (dB(A))	46	51	59	62	65	66
Accoustic pressure Lp (A) at 1.5m	Box radiation (dB(A))	18	27	29	31	36	41

## AIRFLOW/PRESSURE CURVE

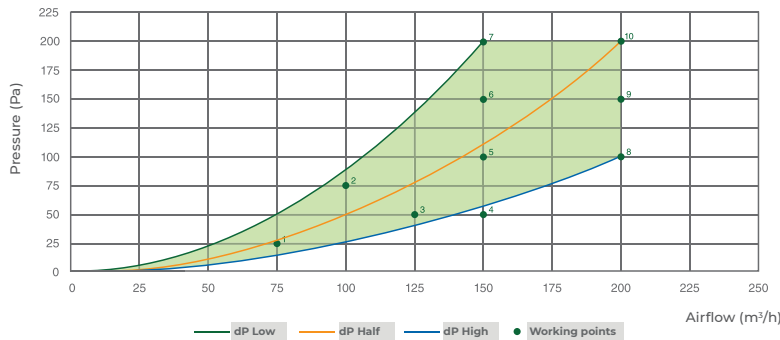
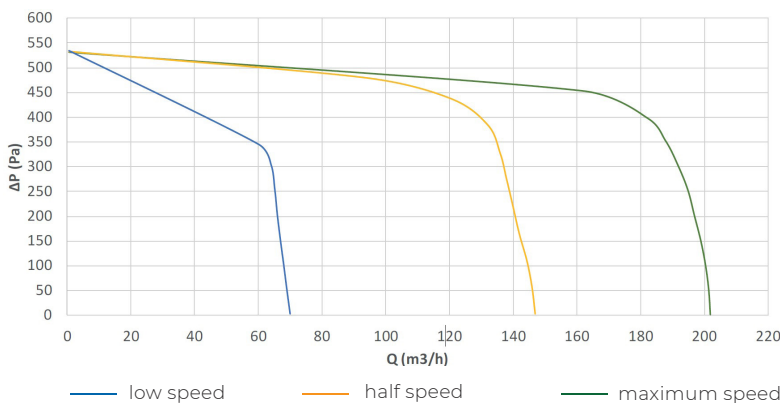

## The enthalpic recovery operating principle

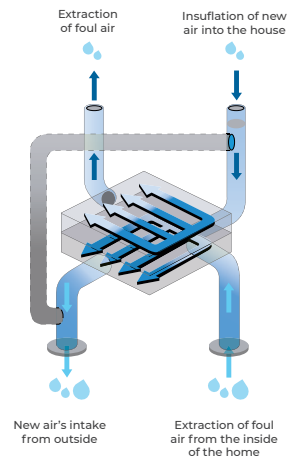

WORKING POINTS	AIRFLOWS (m³/h)	PRESSURE (Pa)	POWER (W)	SFP (W/l/s)
1	75	25	12.61	0.61
2	100	75	25.31	0.91
3	125	50	29.16	0.84
4	150	50	39.20	0.94
5	150	100	49.65	1.19
6	150	150	60.92	1.46
7	150	200	72.60	1.74
8	200	100	81.33	1.46
9	200	150	93.10	1.68
10	200	200	106.48	1.92

## SUSTAINABILITY



### SUSTAINABILITY



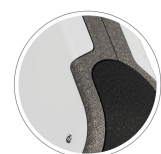



Construction in expanded polypropylene and galvanized steel, reducing the consumption of resources and the degradation of the planet.

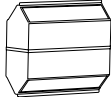
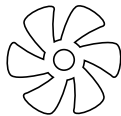
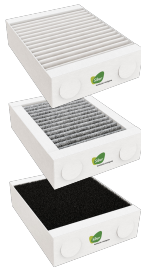
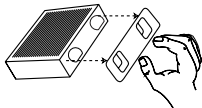
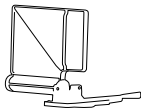
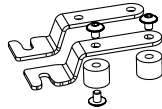

# HIGH PERFORMANCE TECHNICAL CHARACTERISTICS

## Description

## Picture

<b>High performance heat exchanger</b>	Enthalpic, cross flow heat exchanger	
<b>Constant flow fans</b>	Constant flow ventilation technology, direct current centrifugal fan and forward inclined blades. Thanks to this technology, constant flow, acoustic comfort, reduced electrical consumption, easy maintenance and optimum air quality are ensured.	
<b>High efficiency filters (optional)</b>	It has the widest range of filtering on the market, to guarantee optimum air quality.  DFFG4 - FILTER G4 COARSE 65% (1 filter included) DFFF7 - FILTER F7 EPM1 55% (1 filter included) DFFG4F7 - COMBINED FILTER G4 + F7 COARSE 65% - EPM1 55% DFFCA - CARBON FILTER DFFF9 - FILTER F9 EPM1 80% DFFG4F9 - COMBINED FILTER G4 + F9 COARSE 65% - EPM1 80% DFFCAG4 - CARBON FILTER + G4	
<b>Easy maintenance</b>	Easy access to filter cleaning, directly through the front panel. Simple access and removal of the heat exchanger and fans (recommended every 3 years)	
<b>Smart bypass</b>	The 100% automatic by-pass serves both in summer and winter to enjoy any favorable temperature situation inside the house without going through the heat exchanger. This management is automatic (factory configured).	
<b>Quick and easy assembly</b>	Mounting possible both on the ceiling and on the wall, with the possibility of installing the guides on all sides of the equipment thanks to the versatility of the silentblock hooks.	
<b>High performance construction</b>	Watertight internal construction in expanded polypropylene (PPE), and external in galvanized steel covered with RAL 9003 thermo-lacquered paint, guaranteeing acoustic and thermal insulation and air tightness	
<b>Adjustable connections</b>	Modularity in the connection quickly and easily. The connections are designed to ensure maximum tightness. Double symmetric EPDM gasket that guarantees the tightness of the distribution system with the unit	
<b>Low consumption</b>	High performance motors with exclusive technology, ensuring the lowest energy consumption	
<b>Wireless regulation (optional accessories)</b>	With connection to wireless controls and sensors (CO <sub>2</sub> and Relative Humidity). · Wireless intelligent multicontrol remote with electronic regulation and filterfouling indicator. · 4-positions wireless push-button control with LED filter fouling indicator.	
<b>Siber App EVO (optional accessory)</b>	Intelligent control system for online monitoring of the most important elements of indoor air quality in the house	
<b>Gateway/home automation (optional accessories)</b>	KNX - Modbus connectivity. Turn your house into a smart home.	
<b>AirFlows (right and left version)</b>	Possibility of configuring the equipment in 2 versions. Right version (factory presets) and by activating the "mirror mode" we go to the left version in a simple step	